

# ECONOSEAL<sup>®</sup>

## ECONOCASER

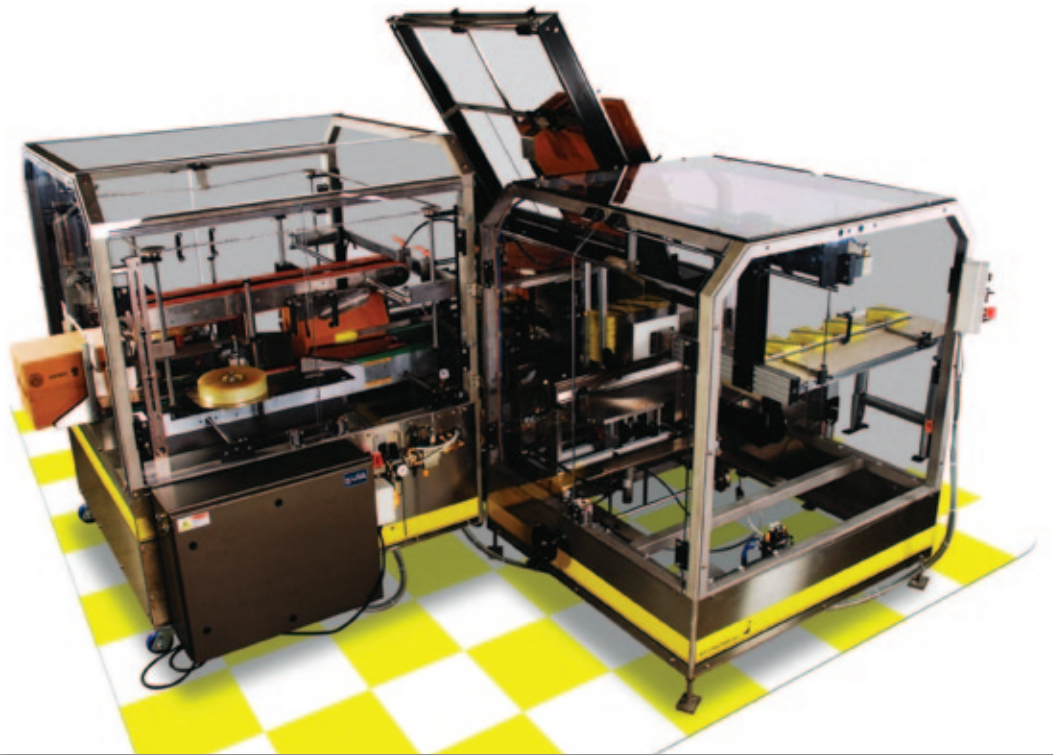

### Simple, Compact, Horizontal Casepacker

The ECONOCASER is a horizontal casepacker of rugged construction that handles corrugated or folding board materials in a variety of case styles. Simple, economical design and operation are features of this machine.

#### Method of Operation:

Master shipping cases are automatically pulled from the supply magazine and erected onto a single load station. Product may then be manually or automatically (optional) loaded. Following loading, the machine cycle is initiated and the loaded case is transported to the closure section for either glue or tape closure.

#### Machine features include:

- Heavy duty construction
- Caster mounting
- Single load station (optional auto loading)
- Pressure sensitive tape or hot melt closure

#### Accommodates:

- Corrugated and folding board materials
- RSC Styles
- Full flap, economy flap and butting end flap constructions

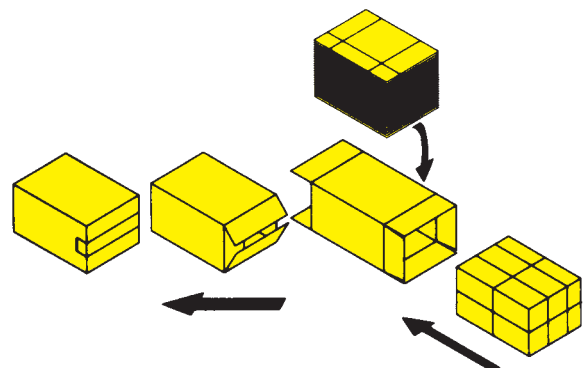

## ECONOCASER:

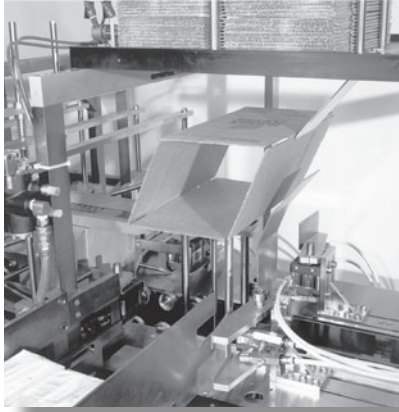

1. Case is automatically erected

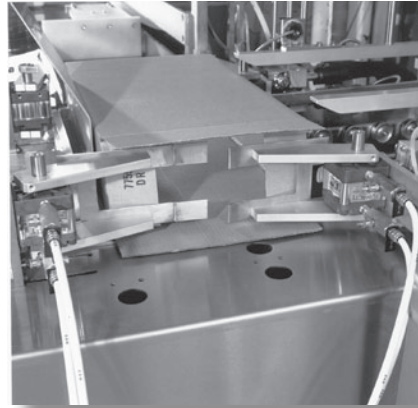

2. Back dust flaps are closed prior to product loading.

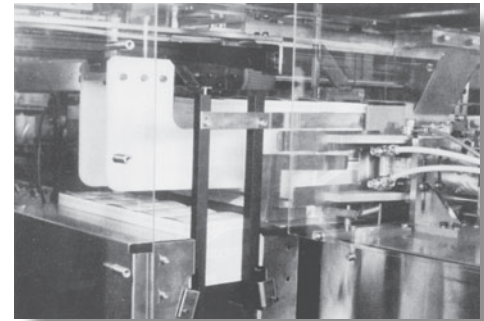

3. Single product load station. Optional product collating/loading feature available.

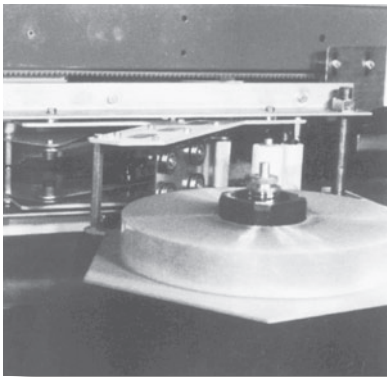

4. Pressure sensitive tape closure.

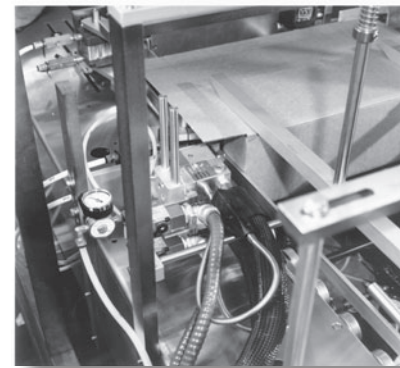

5. Hot melt glue closure.

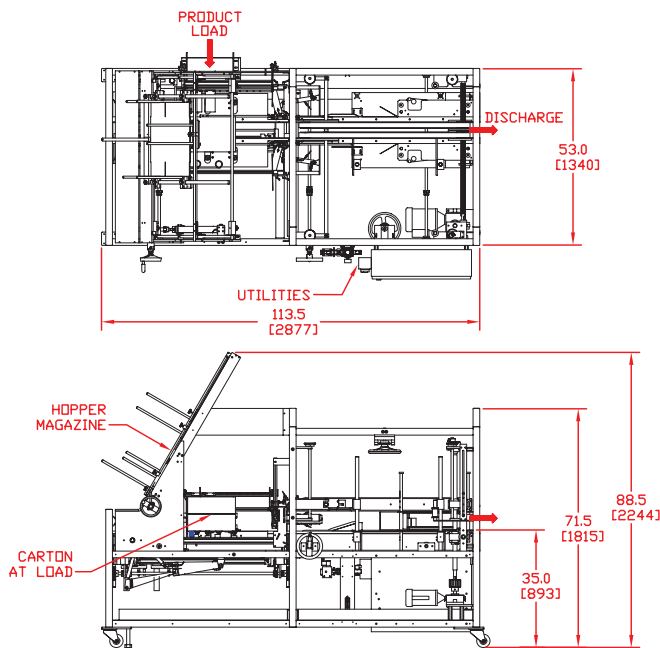

## ECONOCASER ENGINEERING DETAILS

**Size Range:** (Carton/Case Size)  
 Min. 8" x 6" x 4"  
 (203 x 152 x 102mm)  
 Max. 24" x 16" x 18"  
 (609 x 406 x 457mm)

**Speed:** Up to 600 cartons per hour depending on case size and other factors.

**Electrical:** 220 volts 50/60 Hz, Single Phase.

**Air:** 80 psi (5.5 bar). Volume consumption 3.5 CFM, 18.7 SCFM (100 liters/min).

**Shipping:** Normally less than 1900 lbs. (860kg)

Machines available to handle carton sizes outside of range listed above quoted on request. Note: All dimensions are approximate. Subject to change.

**ECONOCORP** INC

Proudly represented by:

**Haluan Sistem Integrasi** / +6289508054752 / info@haluansistemintegrasi.com / www.haluansistemintegrasi.com